

burda Download-Schnitt

Modell 121 Burda Style 04/2009

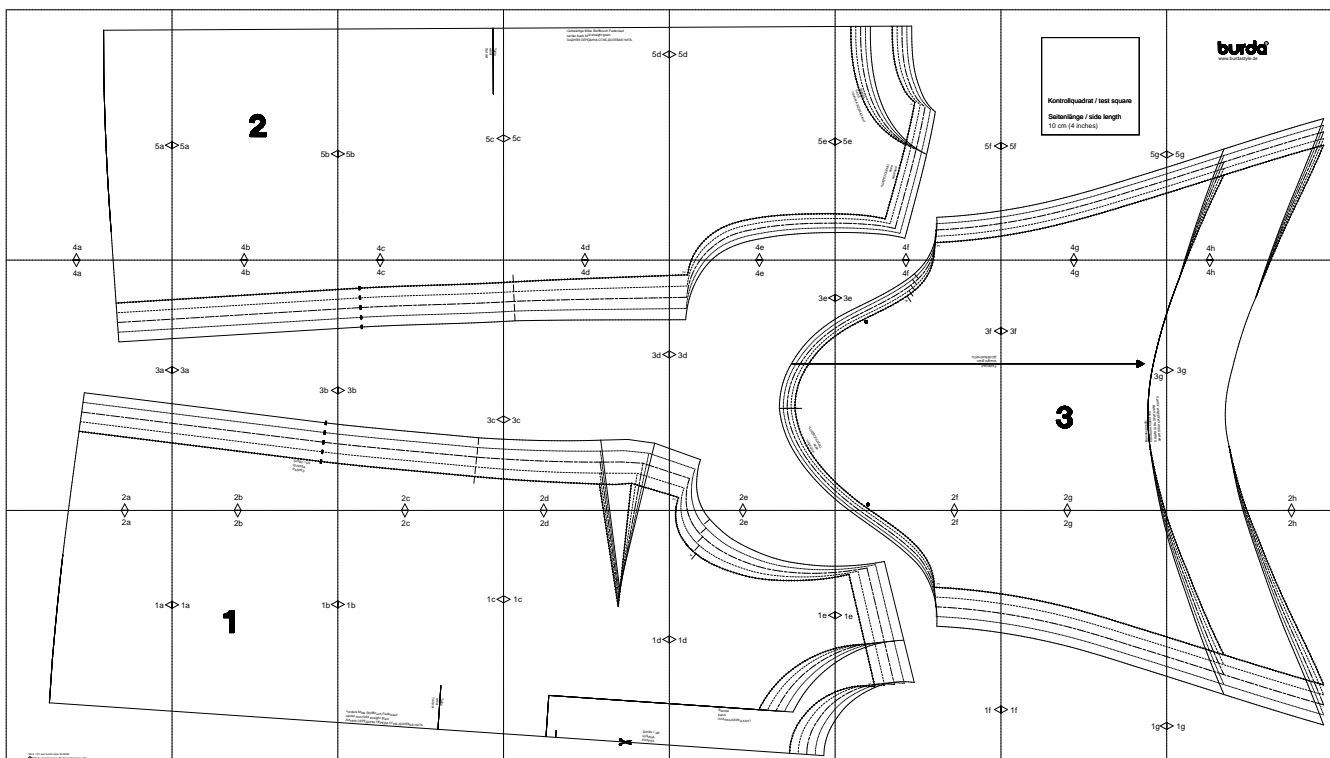

Copyright 2010 by Verlag Aenne Burda GmbH & Co. KG, Am Kestendamm 1, D-77652 Offenburg

Sämtliche Modelle, Schnittteile und Zeichnungen stehen unter Urnehmerschutz, gewerbliches Nacharbeiten ist untersagt.

Der Verlag haftet nicht für Schäden, die durch unsachgemäße Handhabung des Schnitts, der Materialien, unsachgemäße Ausführung der Tipps und Anleitungen oder unsachgemäße Nutzung der Modelle entstehen.



2a

1a

2b

1a

1

1b

2c

1b

1c

Taille
waist
ТАЛИЯ

vordere Mitte Stoffbruch Fadenlauf
center front fold straight grain
ЛИНИЯ СЕРЕДИНЫ ПЕРЕДА СГИБ ДОЛЕВАЯ НИТЬ

2d

1c

1d

Schlitz / slit
ШЛИЦА,
РАЗРЕЗ



2e

4

1e

1d

Blende
band
ПЛАНКА, БЕЙКА, КАНТ

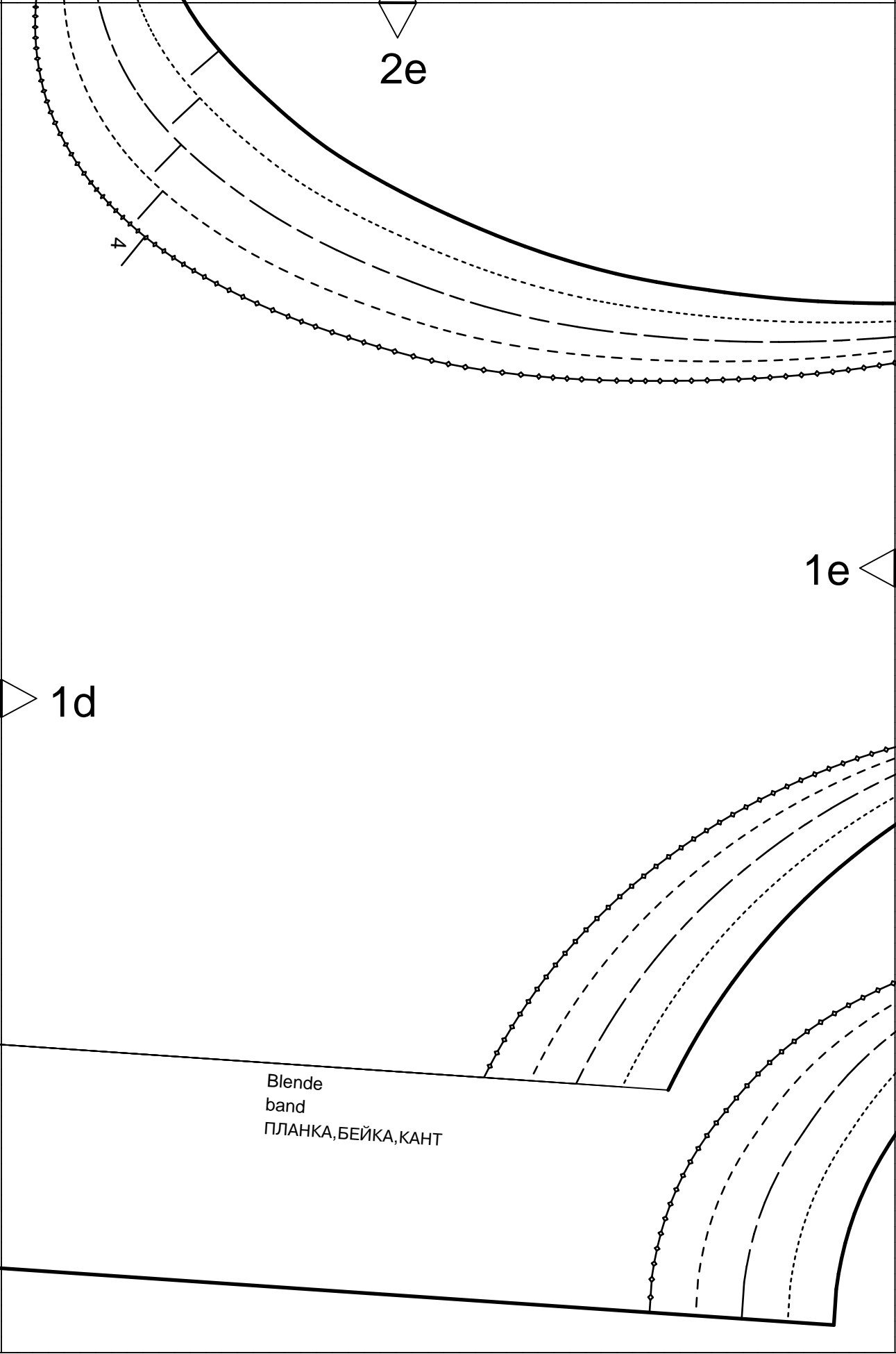

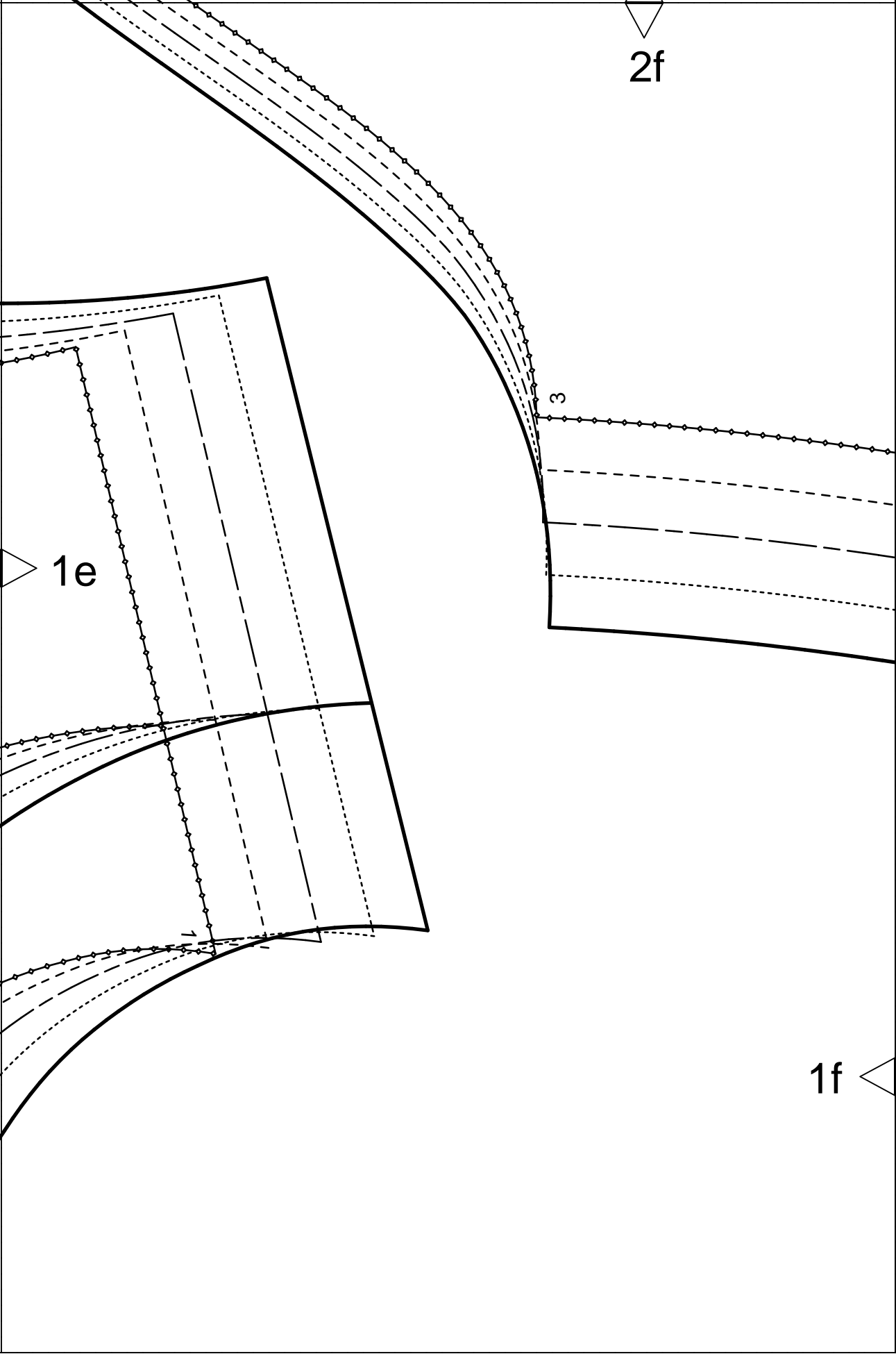

2f

1e

3

1f

$2g$

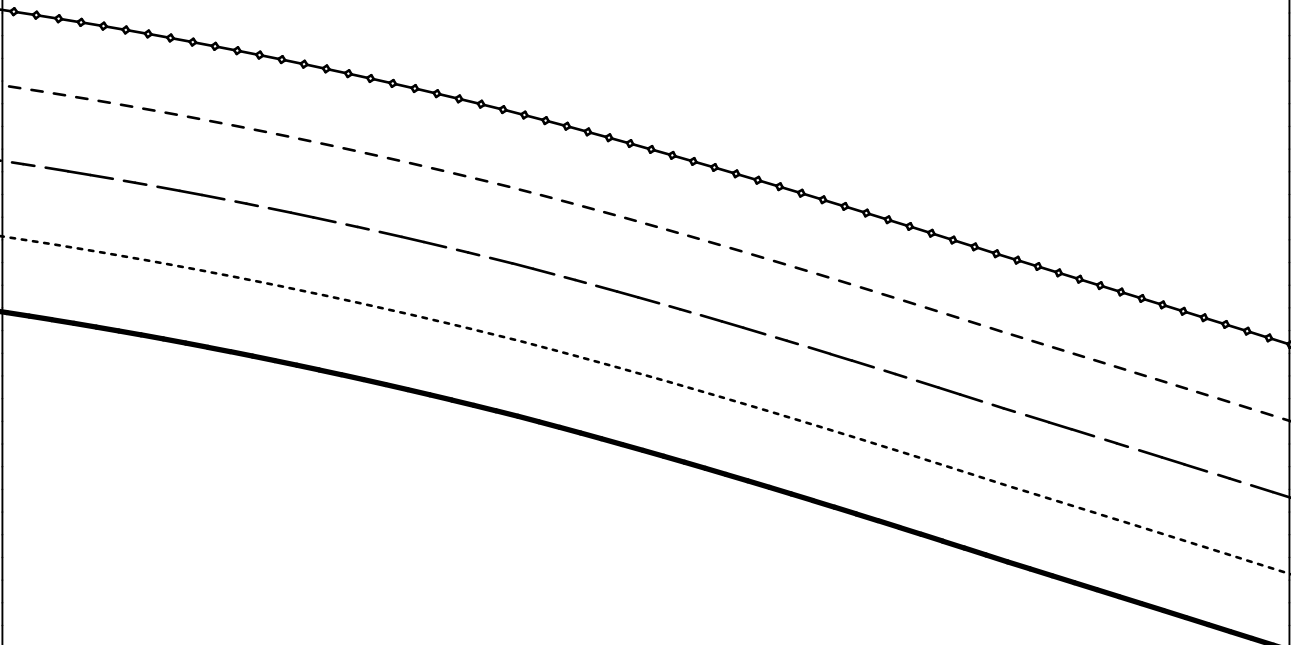

$1f$

$1g$

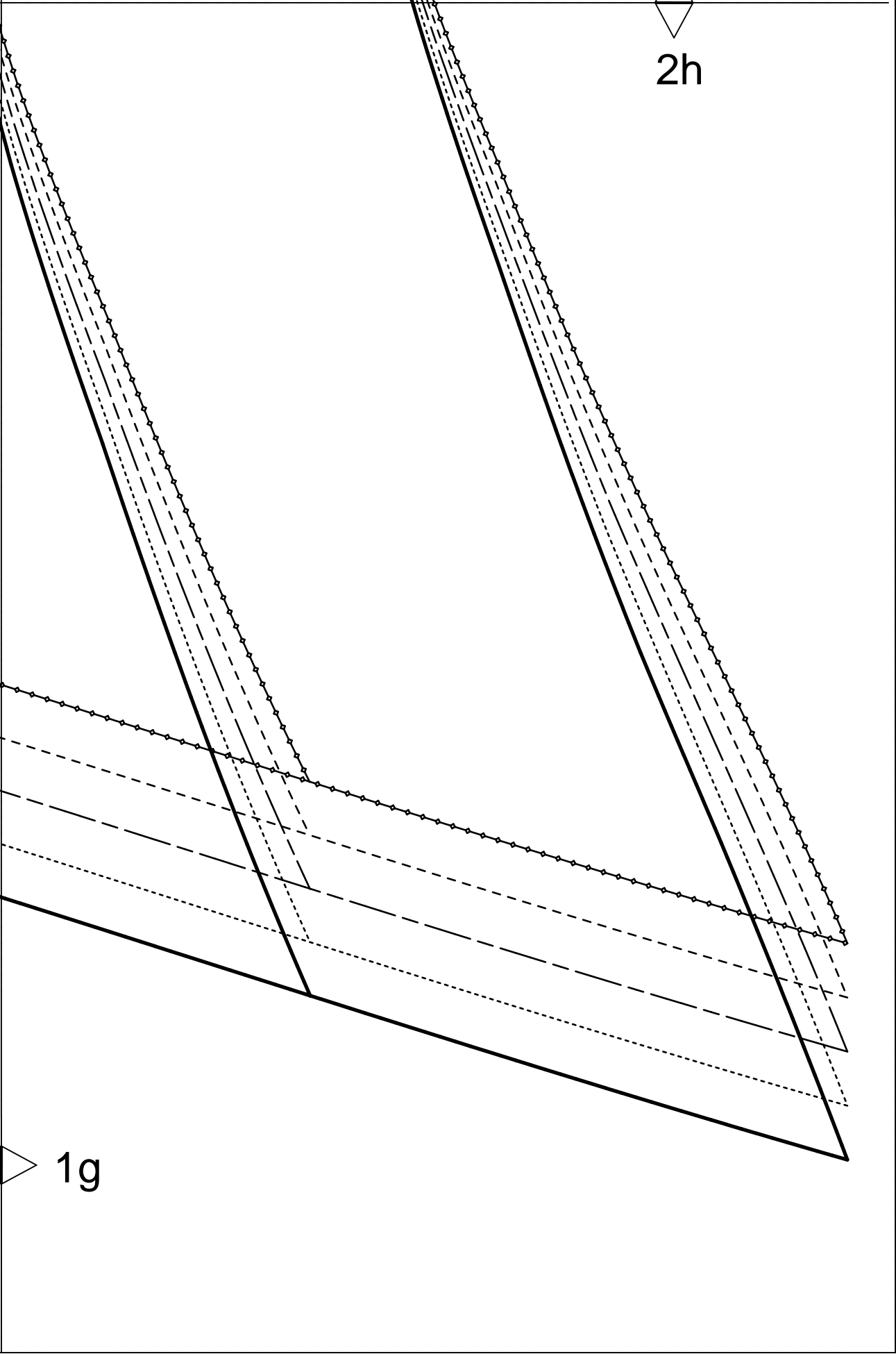

4a

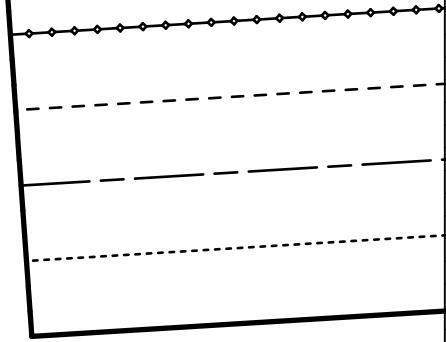

3a

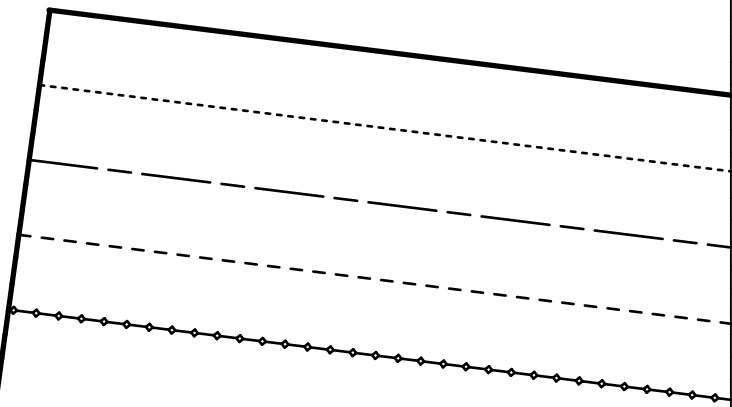

2a



4b

2b

3a

3b

Schlitz / slit
ШЛИЦА,
РАЗРЕЗ

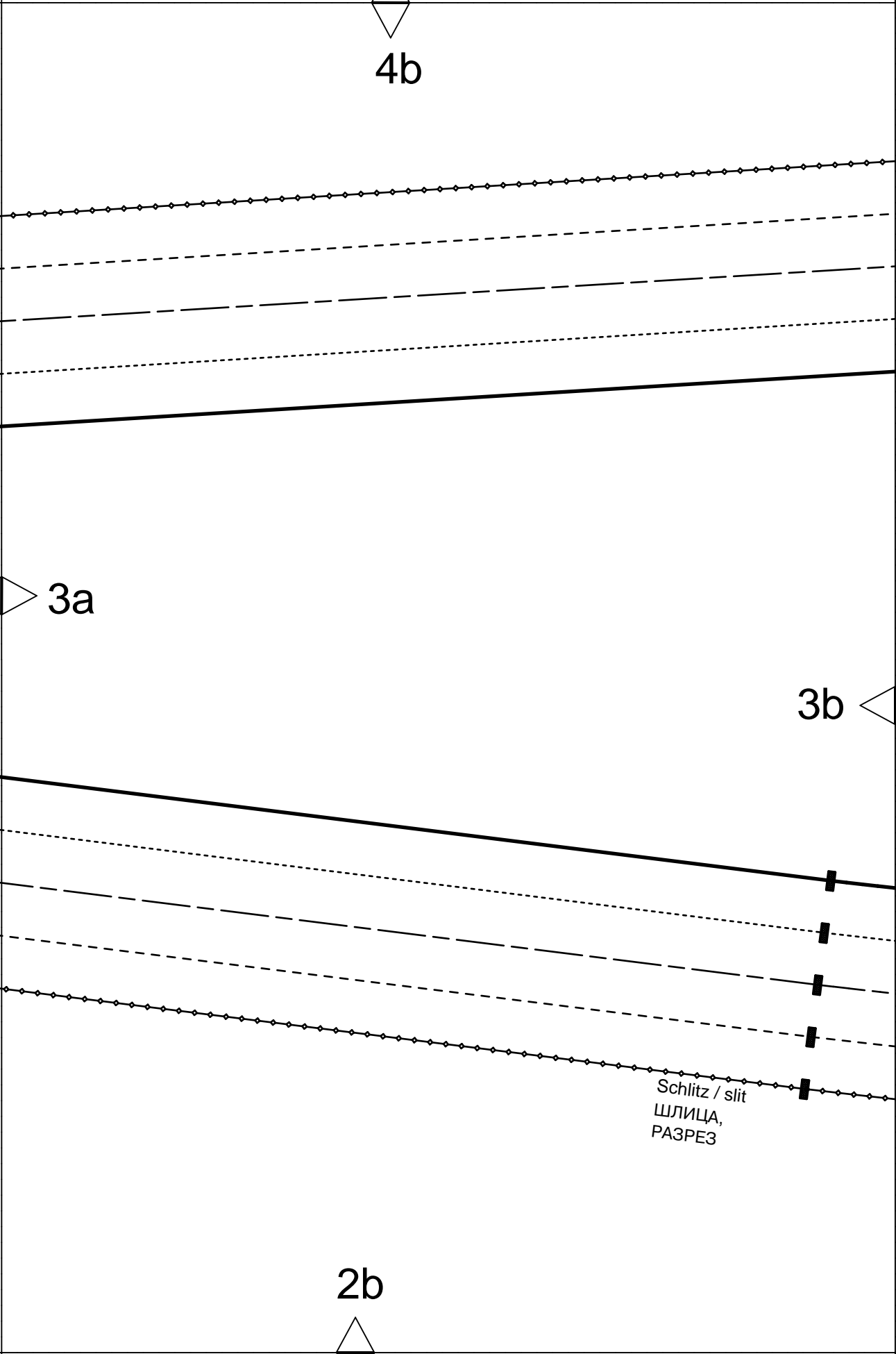

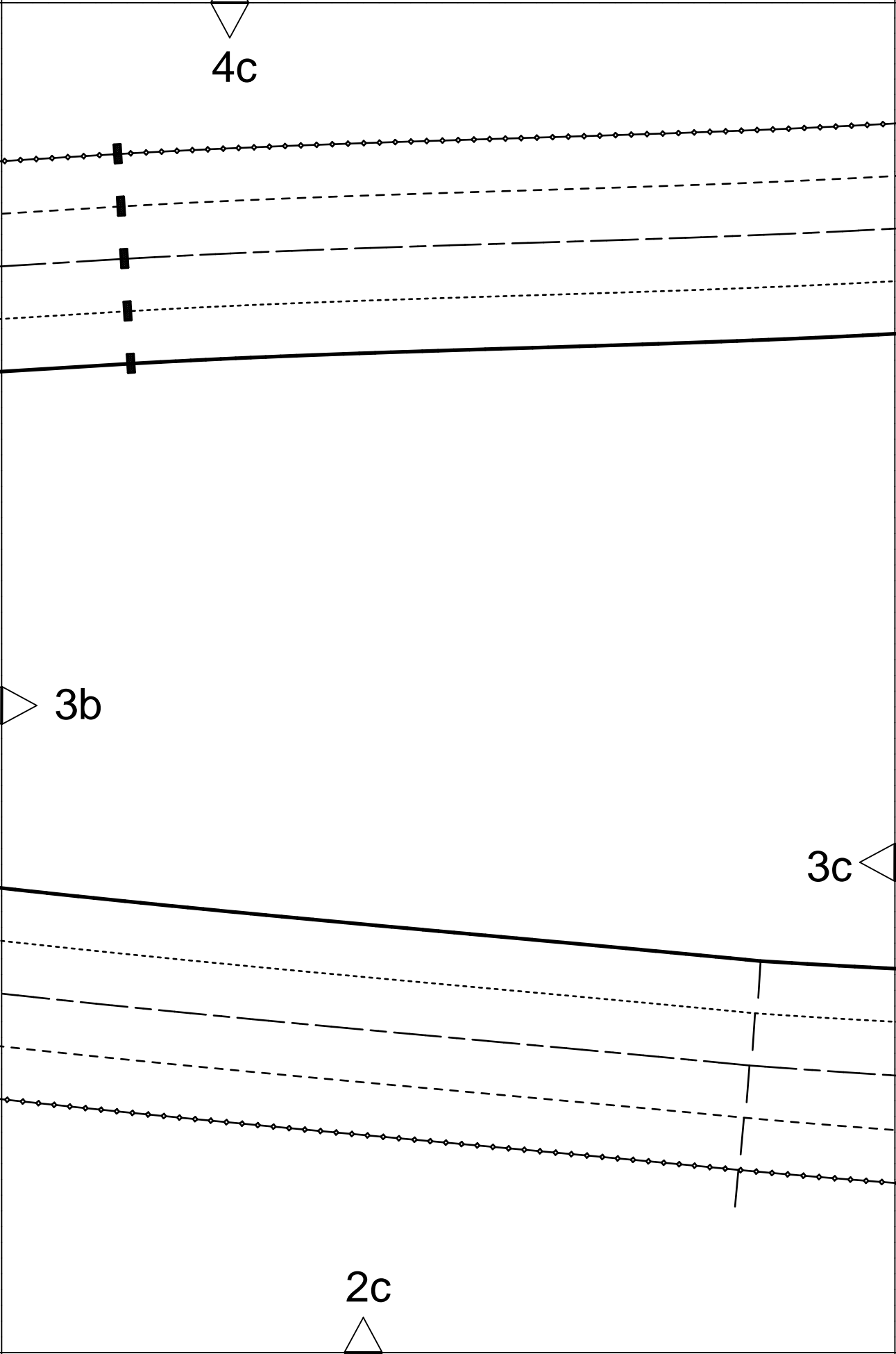

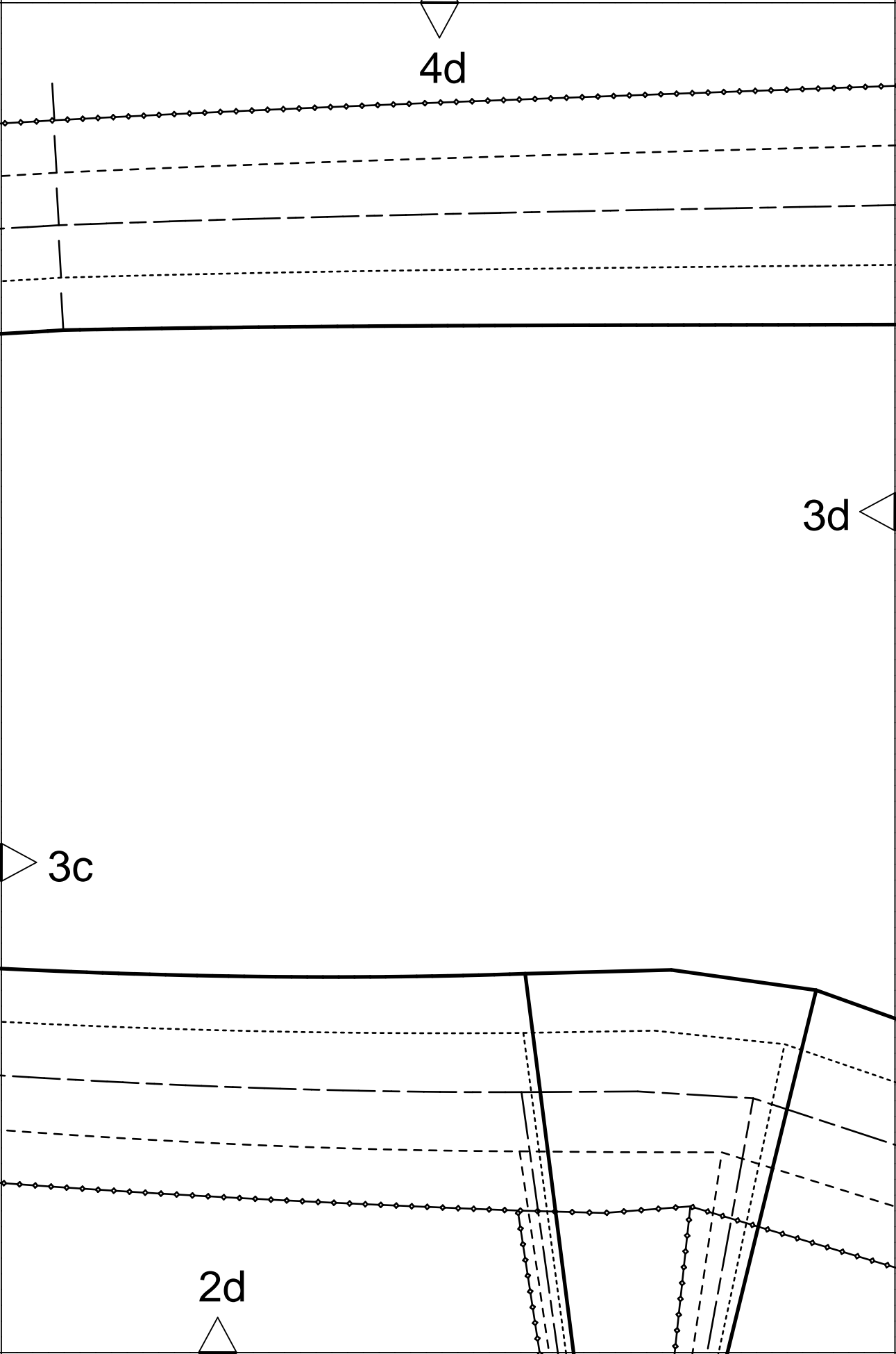

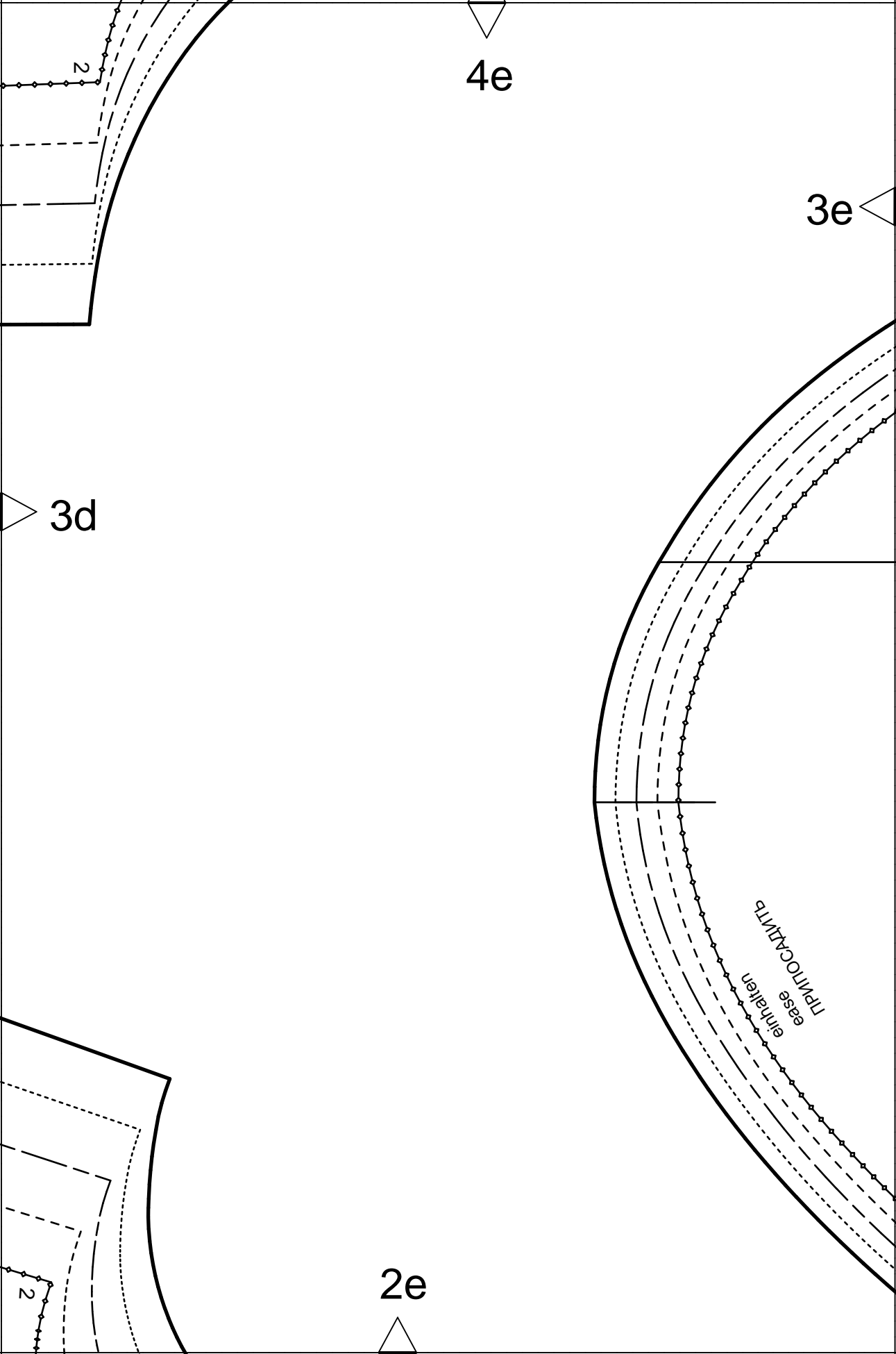

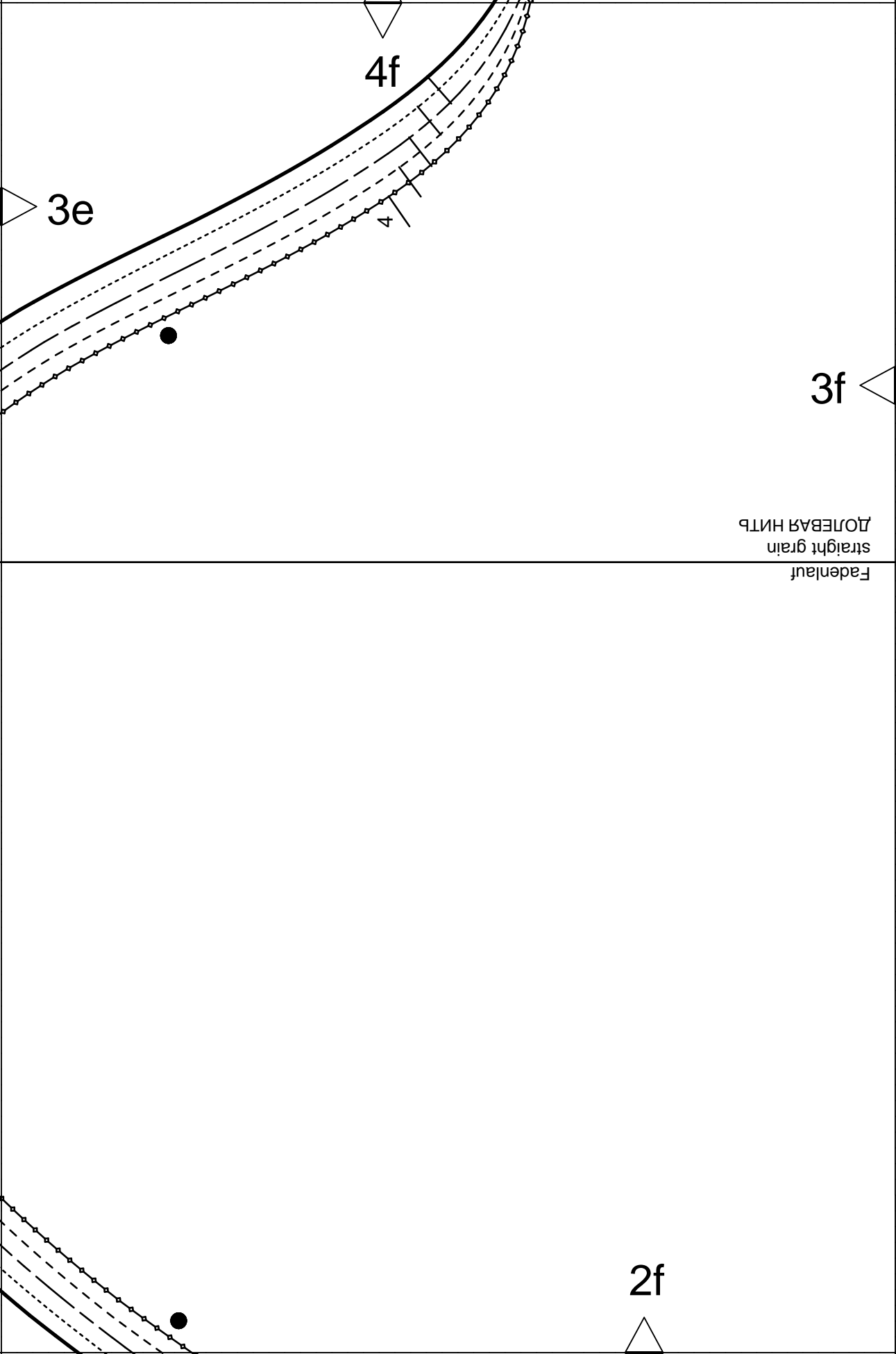

4f

3e

3f

4

Fadenlauf
straight grain
ДОЛБЕВАЯ НИТЬ

2f

4g

3f

3

3g

2g

Blendenansatz
band attachment line
ЛИНІЯ ШВА ПРИТАЧИВ
АНІЯ ПЛАНКИ, БЕЙКИ, КАНТА

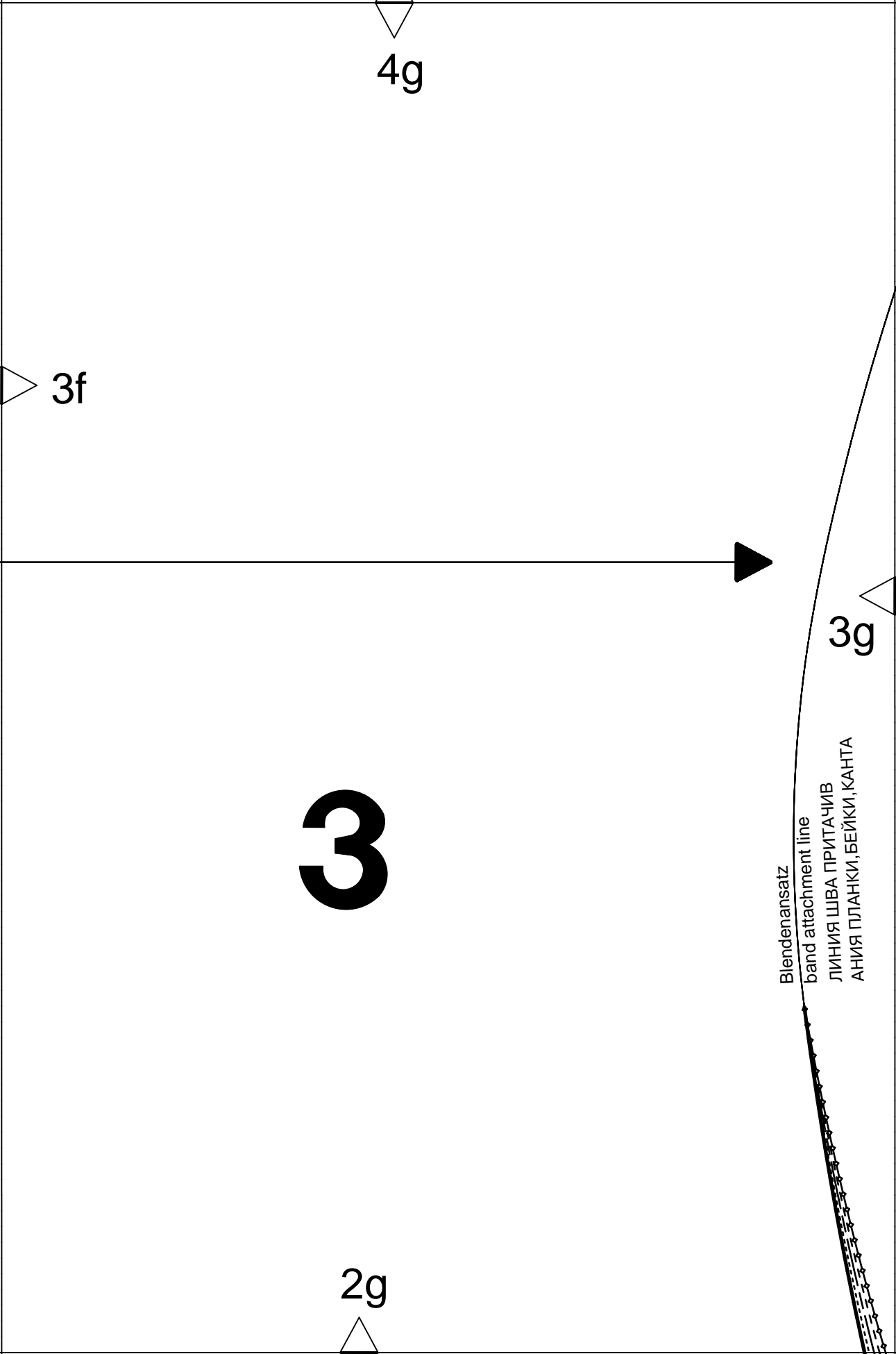

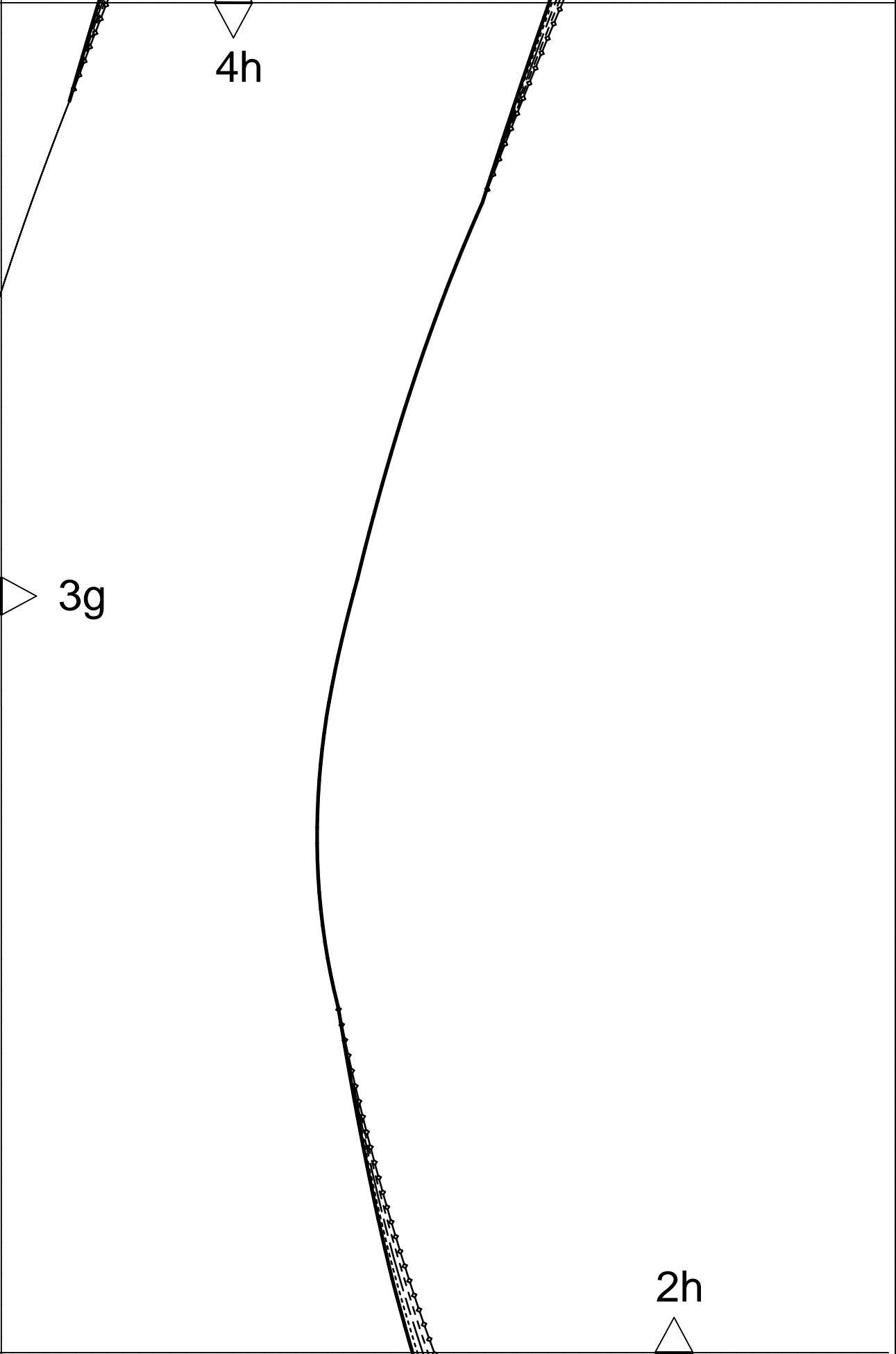

4a



5a



2

5a

5b

4b

Taille
waist
ТАЛИЯ

5c

5b

4c

rückwärtige Mitte Stoffbruch Fadenlauf
center back fold straight grain
ЗАДНЯЯ СЕРЕДИНА СГИБ ДОЛЕВАЯ НИТЬ

5d 

 5c

4d



5d

5e

4e

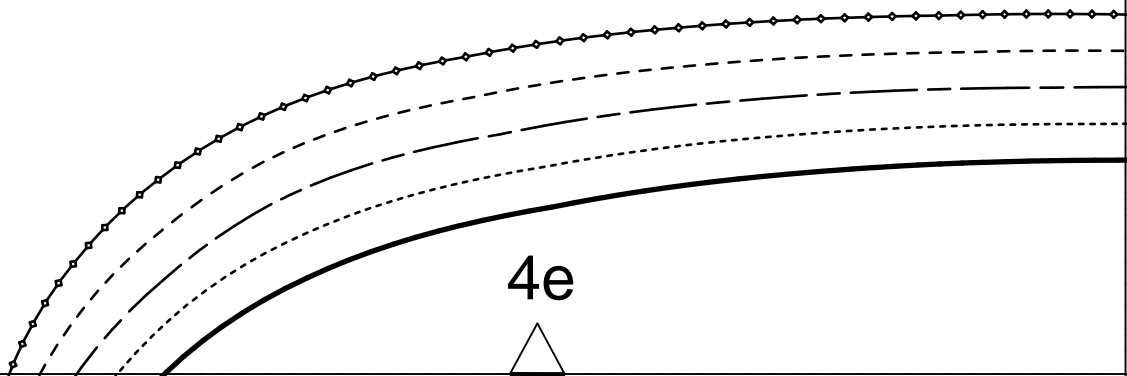

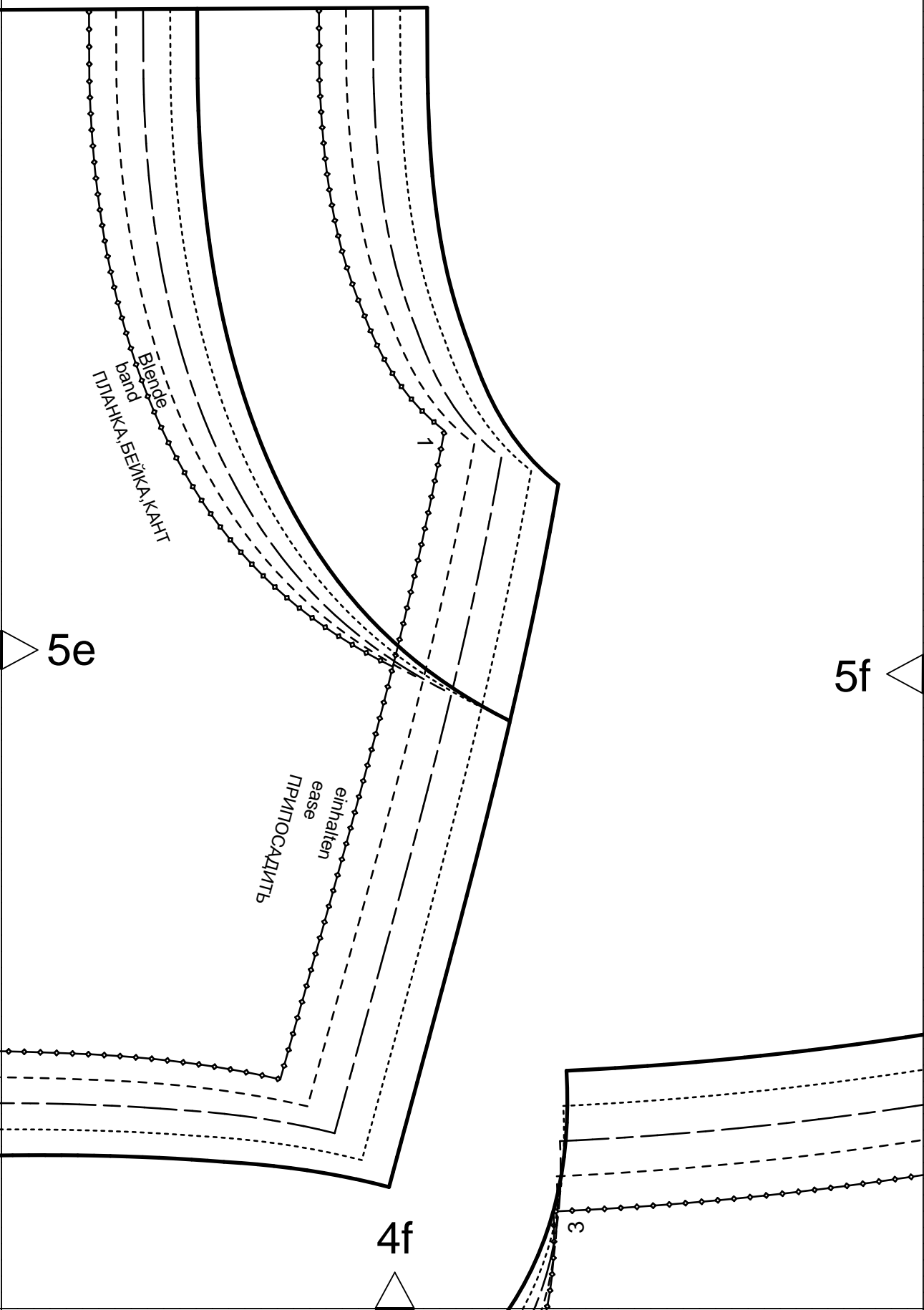

Kontrollquadrat / test square

Seitenlänge / side length
10 cm (4 inches)

5f

5g

4g

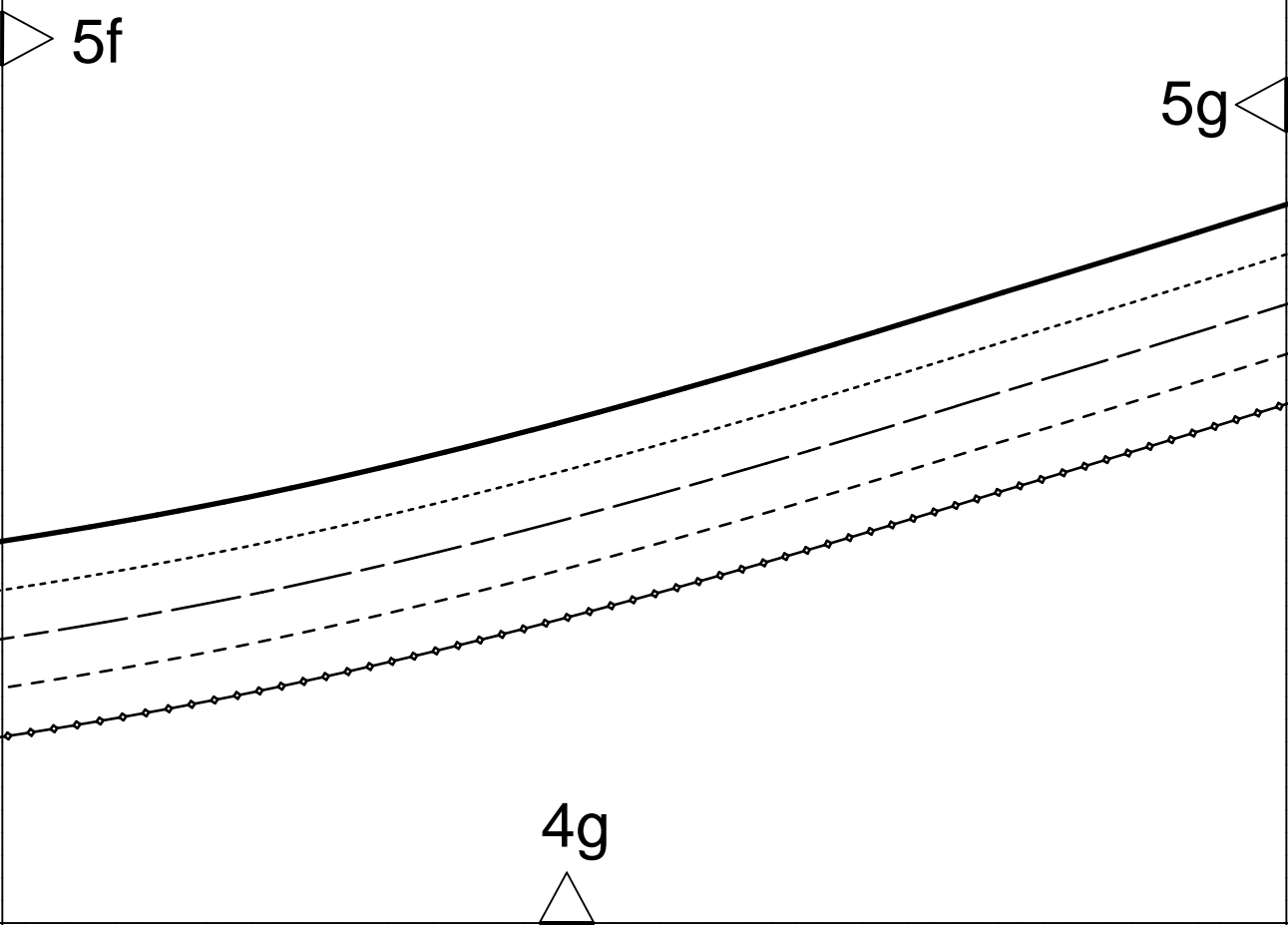

burda[®]

www.burdastyle.de

